

扎带/电缆配件

NYLON CABLE TIES, WIRING ACCESSORIES, ELECTRICAL CONNECTOR

www.gowsen.com

NYLON CABLE TIE / STAINLESS STEEL TIE
NAIL CABLE CLIPS / WIRING ACCESSORIES
ELECTRICAL CONNECTOR / OEM/ODM SERVICE
ISO9001, UL, CE, SGS, RoHS, PAHs, Reach, TUV, CP65.



Gowsen is headquartered in Wenzhou, Zhejiang Province, China. We have over 15 years of experience specializing in the electrical connection and fixation. Our product range includes metal and nylon cable ties, waterproof nylon cable glands, metal cable glands, wire connectors, cable connectors and more. Operating from a facility covering nearly 5000 square meters.

We can quickly respond to the order demands of global customers. Relying on advanced production equipment and automated production lines, we have achieved efficient integrated production from raw materials to finished products, ensuring that we can quickly respond to the order demands of global customers.

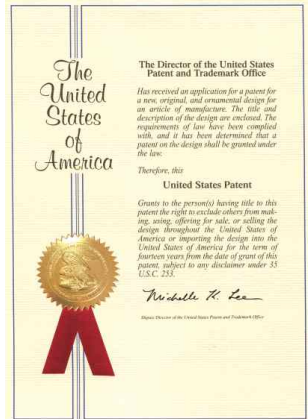
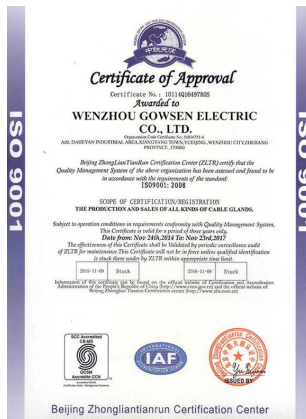
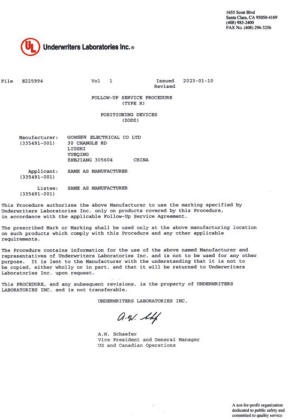



尼龙扎带线
NYLON CABLE TIE



耐寒级扎带
COLD WEATHER CABLE TIE

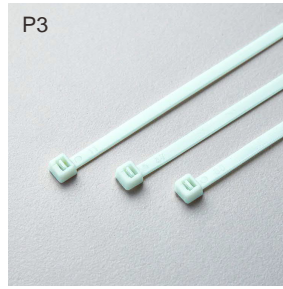

耐高温扎带
EXTRE HIGH TEMPERATURE CABLE TIE



耐候级扎带
WEATHER RESISTANT CABLE TIE

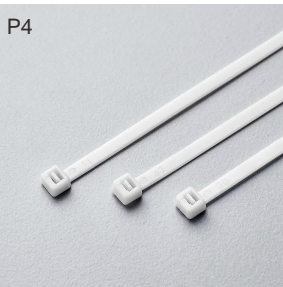

UL94V-0阻燃扎带
FLAME RETARDANT CABLE TIE

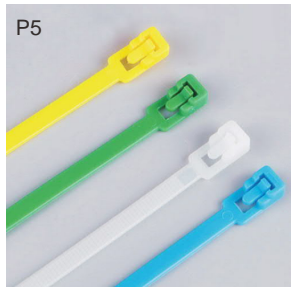

增强型可松式扎带
ENHANCED RELEASABLE CABLE TIE



双扣式尼龙扎带
DOUBLE LOCKING CABLE TIE



标牌扎带
MARKER CABLE TIE

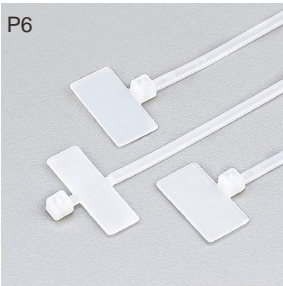

标牌扎带
MARKER CABLE TIE



固定头扎带
MOUNTABLE HEAD TIE



双头扎带
DOUBLE HEAD CABLE TIE



双扣扎带
DOUBLE LOOP MOUNTING TIE



插销式扎带
PUSH MOUNT TIE



尼龙不锈钢嵌片扎带
NYLON STAINLESS STEEL INLAY BLOCK TIE

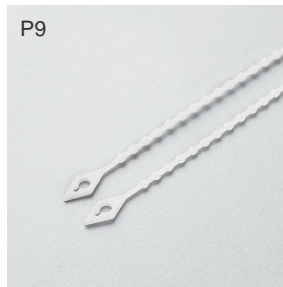

珠孔扎带
KONT TIE(BALL TIE)



鱼骨线扎带
FISHBONE CABLE TIE

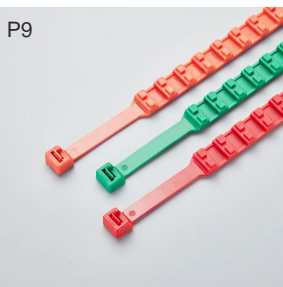

汽车轮胎防滑扎带
TIRE RESCUE TIE



螺纹头扎带
PLUG CABLE TIE



不锈钢扎带
STAINLESS STEEL TIE



喷塑不锈钢扎带
PLASTIC COATED STAINLESS STEEL TIE

P13-14



魔术贴扎带
VELCRO CABLE TIE

P15

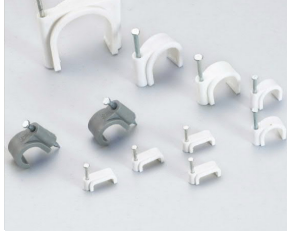

钢钉线卡系列
CABLE CLIPS

P16

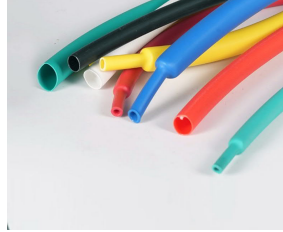

热收缩套管
HEAT-SHRINKABLE TUBINGS

P17

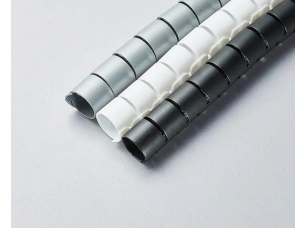

卷式缠绕带
SPIRAL WRAPPING BAND

P18



扎带固定座
SADDLE TYPE TIE MOUNTS

P18



粘式扎带固定座
CABLE TIE MOUNTS

P19



可调式扎带固定座
ADJUSTABLE CABLE TIE MOUNT

P19



螺旋接线帽
WIRE CONNECTORS

P20-21



防水电缆接头
LON CABLE GLAND

P22



防折弯尼龙电缆接头
ANTI-BENDING NYLON CABLE GLAND

P23



金属电缆防水接头
METAL CABLE GLAND

P24-25



防折弯金属电缆接头
ANTI-BENDING METAL CABLE GLAND

P26



电线连接器
CONNECTORS

P26



电线连接器
CONNECTORS

NYLON CABLE TIE

材質: 采用UL認可之尼龍66料制成, 防火等級94V-2, 耐酸、耐蝕、絕緣性良好, 不易老化、承受力強。
顏色: 標準顏色為本色(白色), 另有抗外紫外線之黑色, 特殊顏色歡迎訂做。
備注: 用戶如需要特殊溫度尼龍紮線帶, 本公司可以提供定制。

Material: Nylon 66, 94V-2 certificated by UL. Heat-resisting, erosion control, insulate well and not apt to age.

Color: Natural (or white, standard color), UV black and other colors are available as requested.

Note: If the user needs special temperature nylon cable tie, we can supply.



型號 ITEM NO.	長L		寬W MM	捆紮範圍 E BUNDLE DIAMETER MM	承受力 TENSILE STRENGTH	
	INCH	MM			LBS	KGS
GS-2.5X60	2.4"	60	2.5	2-11	18	8
GS-2.5X80	3.2"	80		2-16		
GS-2.5X100	4.0"	100		2-22		
GS-2.5X120	4.7"	120		2-30		
GS-2.5X150	6.0"	150		2-35		
GS-2.5X160	6.3"	160		2-40		
GS-2.5X200	8.0"	200		3-50		
GS-3.6X140	5.5"	140	3.6	3-33	40	18
GS-3.6X150	6.0"	150		3-35		
GS-3.6X180	7.1"	180		3-42		
GS-3.6X200	8.0"	200		3-50		
GS-3.6X250	10"	250		3-65		
GS-3.6X280	11"	280		3-70		
GS-3.6X300	12"	300		3-80		
GS-3.6X370	14.6"	370		3-105		
GS-3.6X400	16"	400		3-105		
GS-4X100	4"	100		3.6		
GS-4X350	13.7"	350	3-90			
GS-4.8X100	4"	100	4.8	3-22	50	22
GS-4.8X120	4.7"	120		3-30		
GS-4.8X160	6.3"	160		3-40		
GS-4.8X180	7.1"	180		3-42		
GS-4.8X190	7.5"	190		3-46		
GS-4.8X200	8.0"	200		3-50		
GS-4.8X250	10"	250		3-65		
GS-4.8X280	11"	280		3-70		
GS-4.8X300	12"	300		3-80		
GS-4.8X350	14"	350		3-90		
GS-4.8X360	14.2"	360		3-94		
GS-4.8X370	14.6"	370		3-98		
GS-4.8X380	15"	380		3-102		
GS-4.8X400	16"	400		3-105		
GS-4.8X430	16.9"	430		3-120		
GS-4.8X450	17.7"	450		3-130		
GS-4.8X500	19.7"	500		3-150		
GS-4.8X550	21.6"	550		3-162		
GS-4.8X920	36.2"	920	3-265			
GS-5X150	6"	150	4.8	3-35	50	22
GS-5X610	24"	610		8-170		
GS-5X635	25"	635		3-189		

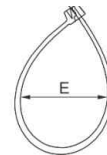



型號 ITEM NO.	長L		寬W MM	捆紮範圍 E BUNDLE DIAMETER MM	承受力 TENSILE STRENGTH	
	INCH	MM			LBS	KGS
GS-7.2X150	6.0"	150	7.2	3-35	120	55
GS-7.2X200	8.0"	200		3-50		
GS-7.2X250	10"	250		4-65		
GS-7.2X280	11"	280		4-78		
GS-7.2X300	12"	300		4-80		
GS-7.2X350	14"	350		4-90		
GS-7.2X370	14.6"	370		4-98		
GS-7.2X380	15"	380		4-100		
GS-7.2X400	16"	400		4-105		
GS-7.2X450	18"	450		4-110		
GS-7.2X500	20"	500		4-150		
GS-7.2X530	20.9"	530		4-160		
GS-7.2X550	21.6"	550		4-165		
GS-7.2X1000	40"	1000		4-300		
GS-7.6X150	6.0"	150	7.6	3-35	120	55
GS-7.6X200	8"	200		3-50		
GS-7.6X250	10"	250		4-65		
GS-7.6X280	11"	280		4-78		
GS-7.6X300	12"	300		4-80		
GS-7.6X350	14"	350		4-90		
GS-7.6X370	14.6"	370		4-98		
GS-7.6X380	15"	380		4-100		
GS-7.6X400	16"	400		4-105		
GS-7.6X450	18"	450		4-110		
GS-7.6X500	20"	500		4-150		
GS-7.6X530	20.9"	530		4-160		
GS-7.6X550	21.6"	550		4-165		
GS-7.6X750	29.5"	750		4-225		
GS-8.8X278	11"	278	8.8	8-75	175	79.4
GS-8.8X400	16"	400		8-105		
GS-8.8X450	18"	450		8-118		
GS-8.8X500	20"	500		8-150		
GS-8.8X550	21.6"	550		8-160		
GS-8.8X600	23.6"	600		8-170		
GS-8.8X650	25.6"	650		8-185		
GS-8.8X720	28.3"	720		10-195		
GS-8.8X750	29.5"	750		10-225		
GS-8.8X800	31.5"	800		10-230		
GS-8.8X900	35.5"	900		10-265		
GS-8.8X1000	40"	1000		10-300		
GS-8.8X1100	43.3"	1100		10-335		
GS-8.8X1200	47.2"	1200		10-370		
GS-9X360	14.2"	360	9.0	10-100	175	79.4
GS-12X600	23.6"	600	12.4	14-170	250	114
GS-12X650	25.6"	650		14-185		
GS-12X750	29.5"	750		14-225		
GS-12X900	35.5"	900		14-265		
GS-15X360	14.2"	360	15.0	15-93	350	160

加厚型 Extra Tensile Strength Ties

GS-2.5X100ET	4.0"	100	2.5	2-22	28	13
GS-3.6X200ET	8.0"	200	3.6	3-50	60	28
GS-4.8X200ET	8.0"	200	4.8	3-50	80	36
GS-4.8X280ET	11"	280		3-70		
GS-4.8X300ET	12"	300		3-80		
GS-4.8X360ET	14.2"	360		3-94		
GS-4.8X370ET	14.6"	370		3-98		
GS-8.8X610ET	24.4"	610	8.8	8-170	230	104
GS-8.8X920ET	36.8"	920		10-265		
GS-8.8X1220ET	48.8"	1220		10-370		

COLD WEATHER CABLE TIE

材質：採用UL認可之尼龍66料制成，耐酸、耐蝕、絕緣性良好，不易老化、承受力強。

適用溫度範圍：-50°C~85°C

安裝溫度範圍：-40°C~85°C

顏色：本色，抗紫外線之黑色。

Material: Nylon 66 certificated by UL. Heat-resisting, erosion control, insulate well and not apt to age.

Application temperature: -50°C~85°C

Installation temperature: -40°C~85°C

Color: Natural, UV black

型號 ITEM NO.	長 L		寬W MM	(最大)捆紮範圍 MAX.BUNDLE DIA. MM	承受力 TENSILE STRENGTH	
	INCH	MM			LBS	KGS
GS-3X100CW	4"	100	2.5	22	18	8
GS-4X150CW	6"	150	3.6	35	40	18
GS-4X200CW	8"	200		53		
GS-5X200CW	8"	200	4.8	53	50	22
GS-5X250CW	10"	250		65		
GS-5X300CW	11 5/8"	300		82		
GS-5X380CW	15"	380		105		
GS-8X300CW	11 5/8"	300	7.6	80	120	55
GS-8X350CW	13 3/4"	350		90		
GS-8X400CW	15 3/4"	400		105		
GS-8X500CW	19 11/16"	500		145		



耐高溫扎帶 EXTRA HIGH TEMPERATURE CABLE TIE

材質：採用UL認可之尼龍66料制成，防火等級94V-2，耐酸、耐蝕、絕緣性良好，不易老化、承受力強。

適用溫度範圍：-40°C~150°C

安裝溫度範圍：-20°C~150°C

顏色：本色。

Material: Nylon 66, 94V-2 certificated by UL. Heat-resisting, erosion control, insulate well and not apt to age.

Application temperature: -40°C~150°C

Installation temperature: -20°C~150°C

Color: Natural

型號 ITEM NO.	長 L		寬W MM	(最大)捆紮範圍 MAX.BUNDLE DIA. MM	承受力 TENSILE STRENGTH	
	INCH	MM			LBS	KGS
GS-3X100HT	4"	100	2.5	22	18	8
GS-4X150HT	6"	150	3.6	35	40	18
GS-4X200HT	8"	200		53		
GS-5X200HT	8"	200	4.8	53	50	22
GS-5X250HT	10"	250		65		
GS-5X300HT	11 5/8"	300		82		
GS-5X380HT	15"	380		105		
GS-8X300HT	11 5/8"	300	7.6	80	120	55
GS-8X350HT	13 3/4"	350		90		
GS-8X400HT	15 3/4"	400		105		
GS-8X500HT	19 11/16"	500		145		

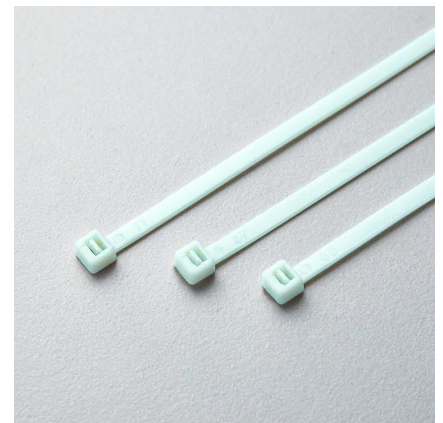



耐候級扎帶 WEATHER RESISTANT CABLE TIE

材質：採用UL認可之尼龍66料制成，防火等級94V-2，耐酸、耐蝕、絕緣性良好，不易老化、承受力強。

適用溫度範圍：-40°C~105°C

安裝溫度範圍：-10°C~105°C

特點：適合戶外及室內受紫外線照射的場所使用。

顏色：抗紫外線之黑色。

Material: Nylon 66, 94V-2 certificated by UL. Heat-resisting, erosion control, insulate well and not apt to age.

Application temperature: -40°C~105°C

Installation temperature: -10°C~105°C

Features: Suitable for outdoor and indoor places exposed to ultraviolet

Color: UV black

型號 ITEM NO.	長 L		寬W MM	(最大)捆紮範圍 MAX.BUNDLE DIA. MM	承受力 TENSILE STRENGTH	
	INCH	MM			LBS	KGS
GS-3X100WR	4"	100	2.5	22	18	8
GS-4X150WR	6"	150	3.6	35	40	18
GS-4X200WR	8"	200		53		
GS-5X200WR	8"	200	4.8	53	50	22
GS-5X250WR	10"	250		65		
GS-5X300WR	11 5/8"	300		82		
GS-5X380WR	15"	380		105		
GS-8X300WR	11 5/8"	300	7.6	80	120	55
GS-8X350WR	13 3/4"	350		90		
GS-8X400WR	15 3/4"	400		105		
GS-8X500WR	19 11/16"	500		145		



UL94V-0阻燃扎帶 FLAME RETARDANT CABLE TIE

材質：採用UL認可之尼龍66料制成，防火等級94V-0，耐酸、耐蝕、絕緣性良好，不易老化、承受力強。

適用溫度範圍：-40°C~85°C

安裝溫度範圍：-10°C~85°C

顏色：乳白色。

Material: Nylon 66, 94V-0 certificated by UL. Heat-resisting, erosion control, insulate well and not apt to age.

Application temperature: -40°C~85°C

Installation temperature: -10°C~85°C

Color: Milk white

型號 ITEM NO.	長 L		寬W MM	(最大)捆紮範圍 MAX.BUNDLE DIA. MM	承受力 TENSILE STRENGTH	
	INCH	MM			LBS	KGS
GS-3X100FR	4"	100	2.5	22	18	8
GS-4X150FR	6"	150	3.6	35	40	18
GS-4X200FR	8"	200		53		
GS-5X150FR	6"	150	4.8	53	50	22
GS-5X250FR	10"	250		65		
GS-5X300FR	11 5/8"	300		82		
GS-5X380FR	15"	380		105		
GS-8X300FR	11 5/8"	300	7.6	80	120	55
GS-8X350FR	13 3/4"	350		90		
GS-8X400FR	15 3/4"	400		105		
GS-8X500FR	19 11/16"	500		145		



增強型扎帶頭可鬆式扎綫帶 ENHANCED RELEASABLE CABLE TIE

材質： UL合格之NYLON 66, 防火等級94V-2, 不易老化。

特點： 可再松開, 重復使用。

Material: Nylon 66 certified by UL.

Usage: These ties, which are easily assembled by hand or with pliers, remain securely locked until intentionally released by operating the finger catch.

型號 ITEM NO.	長L		寬W MM	(最大)捆紮範圍 MAX.BUNDLE DIA. MM	承受力 TENSILE STRENGTH		包裝 PACKING
	INCH	MM			LBS	KGS	
GS-4.8X200RT	8"	200	4.8	50	40	18	100PCS
GS-4.8X300RT	12"	300		53			
GS-4.8X350RT	13 3/4"	350		90			
GS-7.5X150RT	6"	150	7.6	35	50	22	100PCS
GS-7.5X200RT	8"	200		50			
GS-7.5X250RT	10"	250		65			
GS-7.5X300RT	12"	300		80			
GS-7.5X350RT	13 3/4"	350		90			
GS-7.5X400RT	16"	400		100			
GS-7.5X450RT	17 3/4"	450		110			
GS-7.5X500RT	19 11/16"	500		140			



雙扣式尼龍扎帶 DOUBLE LOCKING CABLE TIES

材質： 採用UL認可尼龍66(黑色)料制成, 防火等級94V-2, 耐酸蝕, 不易老化。

特點： 雙鎖式設計、承受力特強。

Material: Nylon 66 94V-2 certified by UL. Acid-control and not easy to age.

Usage: double locking, strong supporting capacity

型號 ITEM NO.	長L		寬W MM	捆紮範圍E BUNDLE DIAMETER MM	拉力 TENSILE STRENGTH		備注 NOTE
	INCH	MM			PA12(KGS)	PA66(KGS)	
GS-6X114SL	4.5"	114	6.0	8-28	18	35	單扣 Solo lock
GS-6X175SL	6.8"	175	6.0	8-40	18	35	
GS-9X180SL	7"	180	9.0	15-45	25	40	
GS-9X180DL	7"	180	9.0	15-45	25	40	雙扣 Double lock
GS-9X260DL	10 1/4"	260	9.0	30-66	40	50	
GS-9X350DL	13 5/8"	350	9.0	30-90	40	50	



單扣

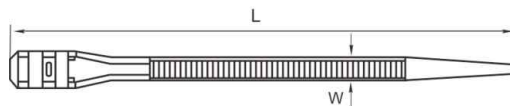

雙扣

標牌扎綫帶 MARKER TIES

材質： 采用UL認可尼龍66料制成，防火等級94V-2，耐酸蝕，不易老化。

特點： 紮帶前端設有空白標牌，可用筆在上面標誌記號。

Material: Nylon 66 94V-2 certificated by UL. Acidcontrol and not easy to age.

Usage: No blank tag at the entrance of cable tie, then write down the marker on the tag.

型號 ITEM NO.	長L		寬W MM	(最大)捆紮範圍 MAX.BUNDLE DIA. MM	承受力 TENSILE STRENGTH		標牌尺寸 MM
	INCH	MM			LBS	KGS	
GS-210MT-A	8.27"	210	4.6	3~40	50	22.0	-



標牌扎綫帶 MARKER TIES

材質： 采用UL認可尼龍66料制成，防火等級94V-2，耐酸蝕，不易老化。

特點： 紮帶前端設有空白標牌，可用筆在上面標誌記號。

Material: Nylon 66 94V-2 certificated by UL. Acidcontrol and not easy to age.

Usage: No blank tag at the entrance of cable tie, then write down the marker on the tag.

型號 ITEM NO.	長L		寬W MM	(最大)捆紮範圍 MAX.BUNDLE DIA. MM	承受力 TENSILE STRENGTH		標牌尺寸 MM
	INCH	MM			LBS	KGS	
GS-100MT-B	4"	100	2.5	3-22	18	8.0	20x10
GS-200MT-B	8"	200	3.6	3-50	22	10.0	25x15
GS-100MT-C	4"	100	2.5	6-22	18	8.0	25x8

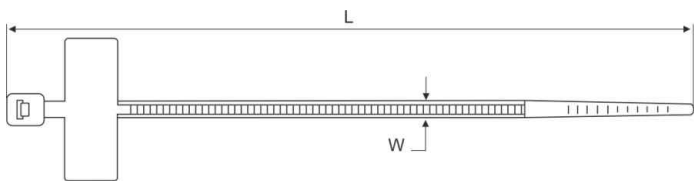
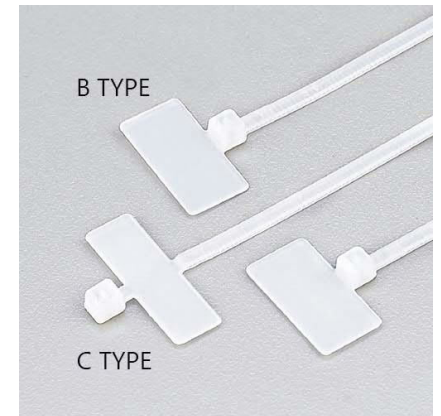



固定頭式扎綫帶 MOUNTABLE HEAD TIES

材質：UL認可之尼龍66料制成。

特點：紮帶捆紮電線後，將整束電線用螺絲固定於基板上。

Material: Nylon 66 certificated by UL.

Usage: after bundling wires, fix them on plate with screw.

型號 ITEM NO.	長L		寬W MM	(最大) 捆紮範圍 MAX.BUNDLE DIA. MM	承受力 TENSILE STRENGTH		包裝 PACKING
	INCH	MM			LBS	KGS	
GS2.5X100MH	4"	100	2.5	22	18	8	100PCS
GS3.6X100MH	4"	100	3.6	22	40	18	
GS3.6X150MH	6"	150	3.6	32			
GS4.8X155MH	6"	155	4.8	30	50	22	
GS4.8X200MHA	8"	200	4.8	42	50	22	
GS4.8X200MHB	8"	200	4.8	42	80	36	
GS4.8X300MH	12"	300	4.8	80	50	22	
GS7.6X300MH	12"	300	7.6	80	120	55	
GS7.6X200MH	8"	200	7.6	50	120	55	
GS7.6X350MH	14"	350	7.6	90	120	55	

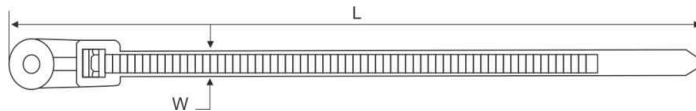

雙頭扎綫帶 DOUBLE HEAD CABLE TIE

材質：UL合格之NYLON 66 (本色)，防火等級94V-2。

Material: Nylon 12 94V-2 certificated by UL.

型號 ITEM NO.	長L		寬W MM	D1		D2		承受力 TENSILE STRENGTH		包裝 PACKING
	INCH	MM		MAX.	MIN.	MAX.	MIN.	IBS	KGS	
GS-225DH	8 7/8"	225	4.8	59	2.5	52	2.0	50	22	100PCS
GS-300DH	11 7/8"	300	4.8	83	2.5	76	2.0	50	22	
GS-370DH	14 9/16"	370	4.8	105	2.5	98	2.0	50	22	

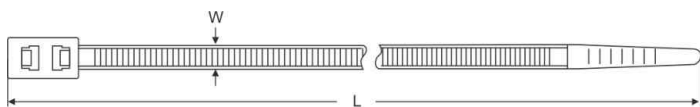

雙扣扎帶 DOUBLE LOOP MOUNTING TIE

材質：UL合格之NYLON 66(黑色)，防火等級94V-2。

用途：束緊管線後，再以螺絲固定於基板上。

特點：1.雙頭雙嚮式設計，透過一條紮綫帶即可平行束緊隔離兩項標的物，不受布線施工，場域大小、方嚮之限制。

2.頭部設有固定孔洞，束緊管線後搭配螺絲便可以固定於基板上。

Material: UL94V-2 flame rated, UL approved Nylon 66.

Color: Black.

Application: double head design to secure wires, tubing or hoses parallelly separated.

Feature: two way insertion head design to facilitate fast wire, hoses, tubing bundling from either direction.

型號 ITEM NO.	長L		寬W MM	捆紮範圍 E BUNDLE DIAMETER MM	承受力 TENSILE STRENGTH	
	INCH	MM			LBS	KGS
GS-700DL	27 9/16"	700	11.8	32~88	397	180





插銷式扎綫帶 PUSH MOUNT TIES

材質: 採用UL認可尼龍66料制成, 防火等級94V-2, 耐酸, 耐蝕, 絕緣性良好、不易老化、承受力強。

使用方法: 先將基板挖孔, 然後把紮帶插入孔內, 再將電線紮緊即可。

Material: Nylon 66, 94V-2, agreed by UL. Acid and corrode resisting, insulate, last long and not apt to age.

Usage: insert tie to the hole of table and tighten it.

型號 ITEM NO.	長L		寬W MM	捆紮範圍 E BUNDLE DIAMETER MM	承受力 TENSILE STRENGTH		孔徑(Ø) HOLE DIA MM	基板厚度 PANEL THICKNESS MM	包裝 PACKING
	INCH	MM			LBS	KGS			
GS-100PT	4"	100	2.5	25	18	8	4.5	2.4	100PCS
GS-150PT	6"	155	3.6	35	40	18	4.6	2.3	
GS-160PT	6 1/4"	160	4.8	35	50	22	6.5	2.5	
GS-200PT	8"	200	4.8	50	50	22	6.0	3.0	

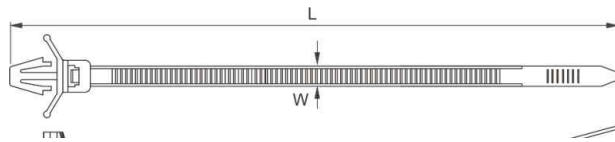

尼龍不銹鋼嵌片扎帶 NYLON STAINLESS STEEL INLAY BLOCK TIES

標準: 尼龍紮帶技術性能完全符合IEC92-3-84標準和GB3126-82《船舶非金屬電纜紮帶》專業標準。紮帶使用環境溫度-25°C-60°C, 抗拉強度符合標準要求。

材質: 採用尼龍66材料制成, 具有絕緣性能好, 難燃性, 操作方便, 省工省本等特點。

Standard: Comply with IEC92-3-84 and GB3126-82 "Non metallic Cable Ties for Ships" standard. Operating environment temperature: -25°C -60°C, High tensile strength.

Material: Nylon 66, with good insulation performance, flame retardancy, and convenient operation.

型號 ITEM NO.	長L		寬W MM	(最大)捆紮範圍 MAX.BUNDLE DIA. MM	承受力 TENSILE STRENGTH		包裝 PACKING
	INCH	MM			LBS	KGS	
GS-3X100T	4"	100	3.0	25	18	8	200PCS
GS-4X150T	6"	150	4.0	35	45	20	
GS-4X200T	8"	200	4.0	50	45	20	
GS-4X280T	11"	280	4.0	70	45	20	
GS-4X370T	14 1/2"	370	4.0	102	45	20	
GS-5X250T	10"	250	5.0	65	50	22	
GS-5X300T	12"	300	5.0	80	50	22	
GS-5X350T	13 3/4"	350	5.0	90	50	22	
GS-5X430T	17"	430	5.0	115	50	22	
GS-8X145T	5 3/4"	145	8.0	32	120	55	
GS-8X175T	7"	175	8.0	42	120	55	
GS-8X200T	8"	200	8.0	50	120	55	
GS-8X240T	9 1/2"	240	8.0	56	120	55	
GS-8X300T	12"	300	8.0	80	120	55	
GS-8X400T	15 3/4"	400	8.0	100	120	55	
GS-10X300T	12"	300	10.0	80	135	60	
GS-10X350T	14"	350	10.0	90	135	60	
GS-10X400T	15 3/4"	400	10.0	105	135	60	
GS-10X450T	17 3/4"	450	10.0	115	135	60	
GS-10X500T	17 11/16"	500	10.0	150	135	60	
GS-10X600T	23 5/8"	600	10.0	170	135	60	



珠孔扎綫帶 KNOT TIE(BALL TYPE)

材質: UL合格之NYLON 66(本色), 防火等級94V-2。
用途: 一般電源線之綁紮,可再松開重複使用。

Material: Nylon 66 certificated by UL.
Usage: Beaded design keeps wires from shifting or slipping.

型號 ITEM NO.	長L		寬W MM	(最大) 捆紮範圍 MAX.BUNDLE DIA. MM	承受力 TENSILE STRENGTH		包裝 PACKING
	INCH	MM			LBS	KGS	
GS-100KTA	4"	100	2.5	25	18	8	100PCS
GS-150KTA	6"	150	2.9	39	18	8	
GS-200KTA	8"	200	3.8	50	18	8	

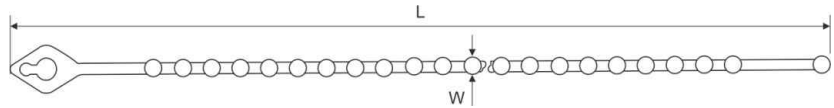

魚骨扎綫帶 FISHBONE CABLE TIE

材質: PE
用途: 捆綁電線作包裝用, 可重複使用。
顏色: 墨綠

Material: Polyethylene PE
Usage: Wrap electrical cords for shipping and packaging. Inexpensive and Releasable.
Color: Dark green

型號 ITEM NO.	長L		寬W MM	(最大) 捆紮範圍 MAX.BUNDLE DIA. MM	承受力 TENSILE STRENGTH		包裝 PACKING
	INCH	MM			LBS	KGS	
GS-150FT	6"	150	5.4	39	30	14	100PCS

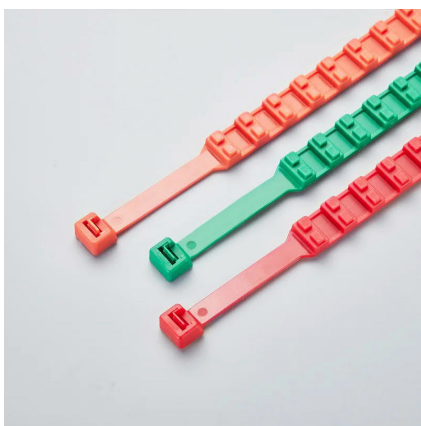
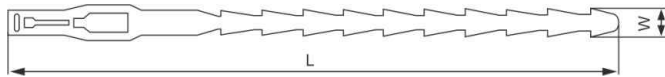

汽車輪胎防滑扎帶 TIRE RESCUE TIE

材質: 採用UL認可之尼龍66料制成, 防火等級94V-2, 耐酸、耐蝕、絕緣性良好, 不易老化、承受力強。
用途: 可以增加輪胎摩擦力, 輕鬆排除車輛受困情形。

Material: Nylon 66, 94V-2 certificated by UL. Heat-resisting, erosion control, insulate well and not apt to age.
Application: Anti-skidding, wear-resisting, easy operating, used upon icy roads and snowfield.

型號 ITEM NO.	長 L		寬W MM	捆紮範圍 E BUNDLE DIAMETER MM	承受力 TENSILE STRENGTH	
	INCH	MM			LBS	KGS
GS-920TRT	36"	920	12	100-260	175	80

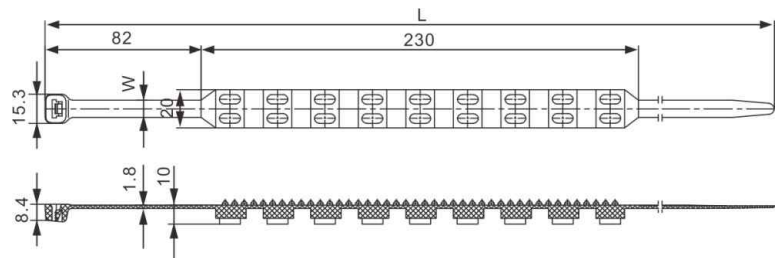



螺紋頭扎綫帶 PLUG CABLE TIE

材質： 采用UL認可尼龍66料制成，防火等級94V-2，耐酸，耐蝕，絕緣性良好、不易老化、承受力強。

使用方法： 先將基板挖孔，然後把紮帶插入孔內，再將電線紮緊即可。

Material: Nylon 66, 94V-2, agreed by UL. Acid and corrode resisting, insulate, last long and not apt to age.

Usage: insert tie to the hole of table and tighten it.

型號 ITEM NO.	長L		寬W MM	捆紮範圍 E BUNDLE DIAMETER MM	適配螺母 NUT DIA	孔徑(Ø) HOLE DIA	基板厚度 PANEL THICKNESS	包裝 PACKING
	INCH	MM				MM	MM	
GS-2.5X110PT	4 3/8"	110	2.5	1~22	M6	4.8~5.5	0.5~5	100PCS

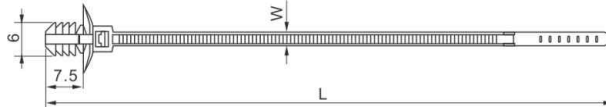

型號 ITEM NO.	長L		寬W MM	捆紮範圍 E BUNDLE DIAMETER MM	適配螺母 NUT DIA	孔徑(Ø) HOLE DIA	基板厚度 PANEL THICKNESS	包裝 PACKING
	INCH	MM				MM	MM	
GS-4.7X165PT	6 1/2"	165	4.7	5~38	M8	7~7.5	0.5~8	100PCS

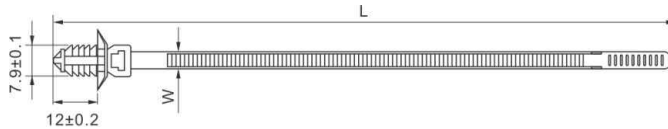

型號 ITEM NO.	長L		寬W MM	捆紮範圍 E BUNDLE DIAMETER MM	適配螺母 NUT DIA	孔徑(Ø) HOLE DIA	基板厚度 PANEL THICKNESS	包裝 PACKING
	INCH	MM				MM	MM	
GS-4.7X220PT	8 9/16"	220	4.7	3~52	M8	6.5~7	1~5	100PCS

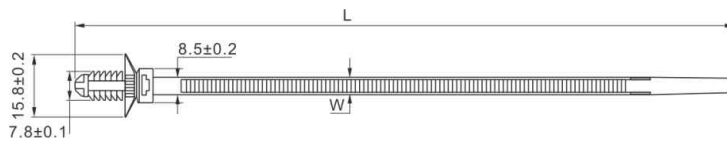

型號 ITEM NO.	長L		寬W MM	捆紮範圍 E BUNDLE DIAMETER MM	適配螺母 NUT DIA	孔徑(Ø) HOLE DIA	基板厚度 PANEL THICKNESS	包裝 PACKING
	INCH	MM				MM	MM	
GS-5.5X210PT	8 1/4"	210	5.5	5~38	M10	8~8.5	1~6	100PCS

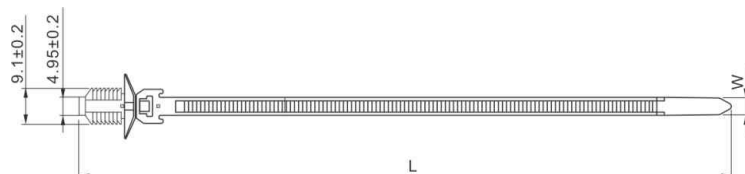

不銹鋼扎帶 STAINLESS STEEL CABLE TIE

材料：採用不銹鋼201、304、316、316L材質，各種長度皆可制作，特殊規格按客戶供樣制作；

特點：耐酸、耐腐蝕、抗張强度高，使用簡單，快捷等優勢；

工作溫度範圍：-60°C~150°C。

Material: All length are available, Stainless steel type: 201, 304, 316, 316L, Special sizes can be customized;

Feature: They have an unique ball locking mechanism that allow easily and quickly installed and not undone, High tensile strength; Non-flammability High resistance to acetic acid, alkali acid, sulphuric acid. corrode ...etc;

Working temperature: -60°C~150°C



型號 ITEM NO.	規格(寬×長) SPECIFICATION (W×L)(mm)	捆紮範圍 BUNDLE DIAMETER(mm)	承受力 TENSILE STRENGTH	
			LBS	KGS
GS-3.8X100SS	3.8*100	12.5-19	135	60
GS-3.8X150SS	3.8*150	12.5-35		
GS-3.8X200SS	3.8*200	12.5-50		
GS-3.8X250SS	3.8*250	12.5-66		
GS-3.8X300SS	3.8*300	12.5-82		
GS-3.8X350SS	3.8*350	12.5-98		
GS-3.8X400SS	3.8*400	12.5-114		
GS-3.8X450SS	3.8*450	12.5-130		
GS-3.8X500SS	3.8*500	12.5-146		
GS-4.6X125SS	4.6*125	15-27		
GS-4.6X150SS	4.6*150	15-35		
GS-4.6X200SS	4.6*200	15-50		
GS-4.6X250SS	4.6*250	15-66		
GS-4.6X260SS	4.6*260	15-70		
GS-4.6X290SS	4.6*290	15-76		
GS-4.6X300SS	4.6*300	15-82		
GS-4.6X350SS	4.6*350	15-98		
GS-4.6X360SS	4.6*360	15-101		
GS-4.6X370SS	4.6*370	15-105		
GS-4.6X380SS	4.6*380	15-108		
GS-4.6X390SS	4.6*390	15-111		
GS-4.6X400SS	4.6*400	15-114		
GS-4.6X430SS	4.6*430	15-124		
GS-4.6X450SS	4.6*450	15-130		
GS-4.6X500SS	4.6*500	15-146		
GS-4.6X550SS	4.6*550	15-162		
GS-4.6X600SS	4.6*600	15-178		
GS-4.6X650SS	4.6*650	15-194		
GS-4.6X700SS	4.6*700	15-210	290	130
GS-4.6X750SS	4.6*750	15-226		
GS-4.6X800SS	4.6*800	15-242		
GS-4.6X900SS	4.6*900	15-273		
GS-4.6X1000SS	4.6*1000	15-305		
GS-6.4X150SS	6.4*150	15-35		
GS-6.4X200SS	6.4*200	15-50		
GS-6.4X250SS	6.4*250	15-66		
GS-6.4X300SS	6.4*300	15-82		
GS-6.4X350SS	6.4*350	15-98		
GS-6.4X400SS	6.4*400	15-114		
GS-6.4X450SS	6.4*450	15-130		
GS-6.4X500SS	6.4*500	15-146		
GS-6.4X550SS	6.4*550	15-162		
GS-6.4X600SS	6.4*600	15-178		

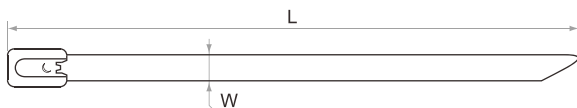



型號 ITEM NO.	規格(寬×長) SPECIFICATION (W×L)(mm)	捆紮範圍 BUNDLE DIAMETER(mm)	承受力 TENSILE STRENGTH	
			LBS	KGS
GS-7.9X150SS	7.9*150	15-35	350	160
GS-7.9X200SS	7.9*200	15-50		
GS-7.9X250SS	7.9*250	15-66		
GS-7.9X280SS	7.9*280	15-76		
GS-7.9X300SS	7.9*300	15-82		
GS-7.9X350SS	7.9*350	15-98		
GS-7.9X360SS	7.9*360	15-101		
GS-7.9X370SS	7.9*370	15-105		
GS-7.9X380SS	7.9*380	15-108		
GS-7.9X390SS	7.9*390	15-111		
GS-7.9X400SS	7.9*400	15-114		
GS-7.9X430SS	7.9*430	15-124		
GS-7.9X450SS	7.9*450	15-130		
GS-7.9X470SS	7.9*470	15-136		
GS-7.9X500SS	7.9*500	15-146		
GS-7.9X550SS	7.9*550	15-162		
GS-7.9X600SS	7.9*600	15-178		
GS-7.9X650SS	7.9*650	15-194		
GS-7.9X700SS	7.9*700	15-210		
GS-7.9X750SS	7.9*750	15-226		
GS-7.9X800SS	7.9*800	15-242		
GS-7.9X850SS	7.9*850	15-257		
GS-7.9X900SS	7.9*900	15-273		
GS-7.9X950SS	7.9*950	15-289		
GS-7.9X1000SS	7.9*1000	15-305		
GS-7.9X1050SS	7.9*1050	15-321		
GS-7.9X1100SS	7.9*1100	15-337		
GS-7.9X1500SS	7.9*1500	15-464		
GS-10X300SS	10*300	18-82	440	196
GS-10X360SS	10*360	18-100		
GS-10X400SS	10*400	18-114		
GS-10X520SS	10*520	18-152		
GS-10X600SS	10*600	18-170		
GS-10X680SS	10*680	18-200		
GS-10X750SS	10*750	18-226		
GS-10X840SS	10*840	18-254		
GS-10X900SS	10*900	18-270		
GS-10X1050SS	10*1050	18-318		
GS-10X1200SS	10*1200	18-365		
GS-12X300SS	12*300	20-82	550	250
GS-12X360SS	12*360	20-101		
GS-12X400SS	12*400	20-114		
GS-12X520SS	12*520	20-152		
GS-12X600SS	12*600	20-178		
GS-12X680SS	12*680	20-203		
GS-12X750SS	12*750	20-226		
GS-12X840SS	12*840	20-254		
GS-12X900SS	12*900	20-273		
GS-12X1050SS	12*1050	20-321		
GS-12X1200SS	12*1200	20-369		
GS-15X300SS	15*300	25-82	660	300
GS-15X360SS	15*360	25-101		
GS-15X400SS	15*400	25-114		
GS-15X520SS	15*520	25-152		
GS-15X600SS	15*600	25-178		
GS-15X680SS	15*680	25-203		
GS-15X750SS	15*750	25-226		
GS-15X840SS	15*840	25-254		
GS-15X900SS	15*900	25-273		
GS-15X1050SS	15*1050	25-321		
GS-15X1200SS	15*1200	25-369		

注：19mm/25mm宽度可定制。 Note: 19mm/25mm width can be customized



噴塑不銹鋼扎帶 PLASTIC COATED STAINLESS STEEL CABLE TIE

材料： 採用不銹鋼201, 304, 316, 316L材質，外噴環氧樹脂熱固性粉塗料，各種長度皆可制作，特殊規格按客戶供樣制作；

特點： 耐酸、耐腐蝕、不易燃燒，抗張强度高，滾珠式結構使紮帶具有簡單，快捷，不可解開等安裝上的優勢；

工作溫度範圍： -40°C~85°C

Material: Stainless steel 201, 304, 316, 316L, PVC coated; All length color are available

Feature: They have an unique hall locking with plastic jetting mechanism that allow easily and quickly installed and not undone, high tensile strength; Non-flammability, self-locked ,easy-quick application, High resistance to acetic acid, alkali acid, sulphuric acid, corrode...etc.

Working temperature: -40°C~85°C

型號 ITEM NO.	規格(寬×長) SPECIFICATION (W×L)(mm)	最大捆紮範圍 MAX.BUNDLE DIA.(mm)	厚度 THICKNESS (mm)	包裝(只/袋) PACKING (PCS/BAG)
GS-4.6X100PS	4.6×100	23	0.25	100
GS-4.6X150PS	4.6×150	38	0.25	100
GS-4.6X200PS	4.6×200	52	0.25	100
GS-4.6X250PS	4.6×250	68	0.25	100
GS-4.6X300PS	4.6×300	82	0.25	100
GS-4.6X350PS	4.6×350	100	0.25	100
GS-4.6X400PS	4.6×400	116	0.25	100
GS-8X150PS	8×150	38	0.25	100
GS-8X200PS	8×200	54	0.25	100
GS-8X250PS	8×250	67	0.25	100
GS-8X300PS	8×300	82	0.25	100
GS-8X350PS	8×350	98	0.25	100
GS-8X400PS	8×400	114	0.25	100
GS-8X450PS	8×450	125	0.25	100
GS-8X500PS	8×500	148	0.25	100



黏扣帶(魔鬼氈/子母扣) Hook & Loop Cable Ties(Velcro)

材質： 公面PP，母面NYLON

顏色： 黑，白，紅，黃，藍，綠。

特點： 1. 黏性強不易脫落，不浪費可重複使用，收尾時，剩余的束帶長度可繼續纏繞黏。
2. 束緊力緩和不會傷害高性能之電纜線。

Material: Hook side: PP / Loop side: NYLON

Color: Black (BK), White (WE), RED (RD), Yellow (YW), Blue (BE), Green (GN)

Feature: 1. Stickiness off strong is not easy, non-reusable waste, ending when the remaining length of the band can continue winding sticky carpet.

2. Force will not hurt to ease the high-performance cable.

TYPE A

型號 TYPE	編號 ITEM NO.	寬 W	長 L	捆紮範圍 BUNDLE DIAMETER	包裝 PKG/PCS
A	GS-200HLA	12	200	5-40	20
	GS-250HLA	22	250	8-65	



A型



TYPE B

型號 TYPE	編號 ITEM NO.	寬 W	長 L	捆紮範圍 BUNDLE DIAMETER	包裝 PKG/PCS
B	GS-125HLB	12	125	5-25	20
	GS-150HLB	12	150	5-30	
	GS-200HLB1	8	200	5-40	
	GS-200HLB2	12	200	5-40	
	GS-230HLB	13	230	5-53	
	GS-240HLB	13	240	5-55	
	GS-330HLB	13	330	5-85	



B型

TYPE C

型號 TYPE	編號 ITEM NO.	寬 W	長 L	捆紮範圍 BUNDLE DIAMETER	包裝 PKG/PCS
C	GS-110HLC	10	110	5-18	20
	GS-170HLC	12	170	5-35	



C型

TYPE D

型號 TYPE	編號 ITEM NO.	寬 W	長 L	捆紮範圍 BUNDLE DIAMETER	包裝 PKG/PCS
D	GS-175HLD	13	175	5-35	20



D型

TYPE E

型號 TYPE	編號 ITEM NO.	寬 W	長 L	捆紮範圍 BUNDLE DIAMETER	包裝 PKG/PCS
E	GS-225HLE	13	225	5-52	20



E型

TYPE F

型號 TYPE	編號 ITEM NO.	寬 W	長 L	捆紮範圍 BUNDLE DIAMETER	包裝 PKG/PCS
F	GS-175HLF	13	175	5-35	20



F型

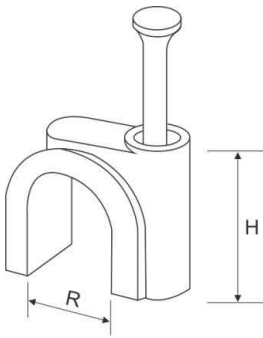

圓型鋼釘纜卡系列 CIRCLE CABLE CLIPS

材質: 采用PE材料制成, 附鋼釘。

使用方法: 將電線置於卡內, 用鐵錘將鋼釘釘上牆壁上即可將電線固定。

用途: 一般室內配線固定電線用。

Material: PE, Steel nail.

How to use: Put the cable under the clip and hammer the nail into the wall to secure the cable.

Application: Securing of cables for general indoor wiring.

型號 ITEM NO.	高 H MM	圓徑R MM	鋼釘Nail MM	包裝 PACKING
GS-3.5CC	4.2	3.5	1.4×15	100pcs
GS-4CC	5.3	4	1.7×15	
GS-5CC	6.5	5	1.7×15	
GS-6CC	8.1	6	1.7×17	
GS-7CC	8.7	7	1.8×20	
GS-8CC	9.6	8	1.9×20	
GS-9CC	10.7	9	2.0×22	
GS-10CC	11.7	10	2.0×25	
GS-12CC	12.8	12	2.05×27	
GS-14CC	14.9	14	2.4×32	
GS-16CC	16.9	16	2.5×35	
GS-18CC	20.8	18	2.5×37	
GS-20CC	23.6	20	2.8×40	
GS-22CC	25.0	22	2.8×42	
GS-25CC	27.7	25	3.0×48	
GS-28CC	33.1	30	3.2×53	
GS-32CC	36.6	35	3.5×58	
GS-40CC	45.2	40	3.5×68	

鈎型鋼釘纜卡系列 HOOK CABLE CLIPS

型號 ITEM NO.	寬 W	鋼釘Nail MM	包裝 PACKING
GS-4-7HC	4-7	2.0×30	100pcs
GS-7-12HC	7-12	2.0×35	
GS-10-14HC	10-14		

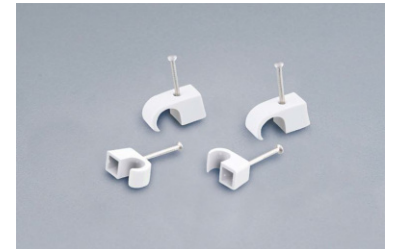

方型鋼釘纜卡系列 SQUARE CABLE CLIPS

材質: 采用PE材料制成, 附鋼釘。

使用方法: 將電線置於卡內, 用鐵錘將鋼釘釘上牆壁上即可將電線固定。

用途: 一般室內配線固定電線用。

Material: PE, Steel nail.

How to use: Put the cable under the clip and hammer the nail into the wall to secure the cable.

Application: Securing of cables for general indoor wiring.

型號 ITEM NO.	外高 H (MM)	內徑 Circle Path		鋼釘Nail (MM)	包裝 PACKING
		H1(MM)	R(MM)		
GS-4SC	6.0	3.8	4	1.7×15	100pcs
GS-5SC	6.0	3.8	5		
GS-6SC	6.5	4.1	6		
GS-7SC	7.0	4.7	7	1.8×20	
GS-8SC	7.5	5.0	8		
GS-9SC	8.2	5.4	9		
GS-10SC	8.6	5.7	10	2.0×22	
GS-12SC	9.0	6.1	12		
GS-14SC	11.2	6.5	14		
GS-16SC	11.6	8.4	16	2.05×27	
GS-20SC	13.6	10.2	20	2.4×32	

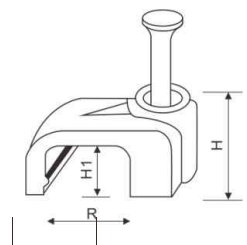



無滷阻燃熱收縮套管 HEAT-SHRINKABLE TUBE

應用範圍:

- 1.電線之保護與絕緣。
- 2.端子與電接線頭之絕緣與保護。
- 3.分色作用。
- 4.防水。
- 5.電阻電容器之保護與絕緣標誌顏色(透光): 黑、白、紅、藍、黃、綠、棕、灰、橙、紫。

Application:

UL2240,105°C,660V,VW-1,CSA,125°C,660V,OFT

F: 105°C(UL,CSA合格)

F2: 125°C(UL,CSA合格)

F32: 125°C(UL,CSA合格)

型號 ITEM NO.	收縮前AS SUPPLIED		收縮後AFTER SHRINKAGE		適用範圍 APPLICATION (mm)	包裝 PACKING (M/ROLL)
	內徑 I.D(mm)	厚度 THICKNESS	內徑 I.D(mm)	厚度 THICKNESS		
GS-0.8HT	1.0±0.2	0.2±0.05	0.4±0.1	0.22±0.05	0.6~0.8	200
GS-1.0HT	1.4±0.3	0.2±0.05	0.4±0.1	0.28±0.05	0.75~0.9	200
GS-1.5HT	1.9±0.3	0.2±0.05	0.6±0.1	0.32±0.05	0.95~1.4	200
GS-2.0HT	2.4±0.3	0.25±0.05	0.9±0.1	0.35±0.05	1.1~1.8	200
GS-2.5HT	2.9±0.3	0.25±0.05	1.1±0.1	0.38±0.05	1.35~2.3	200
GS-3.0HT	3.4±0.4	0.25±0.05	1.4±0.1	0.40±0.05	1.6~2.7	200
GS-3.5HT	3.9±0.4	0.25±0.05	1.6±0.1	0.42±0.05	1.85~3.2	200
GS-4.0HT	4.5±0.4	0.25±0.05	1.8±0.1	0.45±0.05	2.1~3.6	200
GS-4.5HT	4.8±0.4	0.25±0.15	1.9±0.1	0.50±0.15	2.35~4.0	100
GS-5.0HT	5.4±0.4	0.25±0.15	2.3±0.1	0.55±0.15	2.6~4.5	100
GS-6.0HT	6.4±0.4	0.28±0.15	2.8±0.2	0.55±0.15	3.1~5.4	100
GS-7.0HT	7.4±0.4	0.28±0.15	3.3±0.2	0.55±0.15	3.7~6.3	100
GS-8.0HT	8.4±0.5	0.28±0.15	3.8±0.2	0.55±0.15	4.2~7.2	100
GS-9.0HT	9.4±0.5	0.30±0.15	4.3±0.2	0.55±0.15	4.7~8.0	100
GS-10HT	10.5±0.5	0.30±0.15	4.8±0.2	0.55±0.15	5.2~9.0	100
GS-11HT	11.5±0.5	0.30±0.15	5.3±0.2	0.60±0.15	5.7~10	100
GS-12HT	12.5±0.5	0.30±0.15	5.7±0.3	0.60±0.15	6.2~11	100
GS-13HT	13.5±0.5	0.33±0.15	6.2±0.3	0.60±0.15	6.7~12	100
GS-14HT	14.5±0.5	0.35±0.15	6.7±0.3	0.60±0.15	7.3~13	100
GS-15HT	15.5±0.6	0.38±0.15	7.2±0.3	0.65±0.15	7.8~14	100
GS-16HT	16.5±0.6	0.38±0.15	7.7±0.3	0.65±0.15	8.3~15	100
GS-17HT	17.5±0.6	0.38±0.15	8.2±0.3	0.65±0.15	8.8~16	100
GS-18HT	19.0±0.6	0.40±0.15	8.7±0.3	0.65±0.15	9.3~17	100
GS-20HT	21.0±0.8	0.40±0.20	9.7±0.3	0.75±0.20	10.4~19	100
GS-22HT	22.8±0.8	0.42±0.20	10.0±1.0	0.75±0.20	11.4~21	100
GS-25HT	25.8±0.8	0.45±0.20	11.0±1.0	0.75±0.20	12.8~24	50
GS-28HT	28.8±0.8	0.45±0.20	13.0±1.0	0.75±0.20	14.4~29	50
GS-30HT	30.8±0.8	0.45±0.20	14.0±1.0	0.75±0.20	16~29	50
GS-35HT	35.8±0.8	0.50±0.20	16.0±1.0	0.85±0.20	18~34	50
GS-40HT	42.0±1.0	0.50±0.20	19.0±1.0	0.85±0.20	21~39	50
GS-50HT	51.0±1.0	0.50±0.20	24.0±1.0	0.85±0.20	26~49	50
GS-60HT	61.0±1.0	0.65±0.20	29.0±1.0	0.85±0.20	35~55	25
GS-70HT	71.0±1.0	0.65±0.20	33.0±2.0	1.00±0.20	40~65	25
GS-80HT	81.0±1.0	0.65±0.20	37.0±2.0	1.00±0.20	45~75	25
GS-90HT	91.0±1.0	0.65±0.20	43.0±2.0	1.00±0.20	50~88	25
GS-100HT	102.0±2.0	0.65±0.20	48.0±2.0	1.00±0.20	55~95	25
GS-120HT	122.0±2.0	0.80±0.20	58.0±2.0	1.50±0.20	65~115	15
GS-150HT	152.0±2.0	0.80±0.20	73.0±2.0	1.50±0.20	80~145	15
GS-180HT	182.0±2.0	0.80±0.20	88.0±2.0	1.50±0.20	95~175	15

卷式纏繞帶 SPIRAL WRAPPING BAND

材質： 採用PE料制成。

使用方法： 先用保護帶固定起點一端，然後按順時針方向環繞束緊，即可將電線束為一體。

用途： 作為保護電線不受磨損及絕緣用，並可改進電線彎曲的美觀。

Material: Made from PE.

Usage: fix one end with safety belt first, then circle the wires clockwise to make them tighten.

Application: a protection wear for electric wires, and make them insulation and look nice.



型號 ITEM NO.	內徑 d(mm)	外徑 D(mm)	螺距 W(mm)	結束可能範圍(mm) WRAPPING RANGE	包裝 PACKING
GS-6SW	4	6	7.0	4-50	10m
GS-8SW	6	8	10.8	6-60	
GS-10SW	7.5	10	11.4	7.5-60	
GS-12SW	9	12	13.9	9-65	
GS-16SW	13	16	15.0	12-70	
GS-20SW	16	20	18.2	15-100	
GS-25SW	21	25	19.6	20-130	

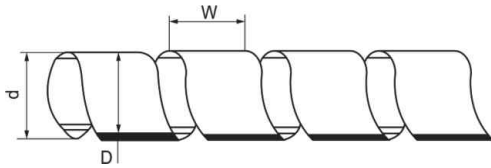

卷式結束保護帶(纏繞管) SPIRAL WRAPPING BANDS

材質： 採用PE料制成。

使用方法： 先用保護帶固定起點一端，然後按順時針方向環繞束緊，即可將電線束為一體。

用途： 作為保護電線不受磨損及絕緣用，並可改進電線彎曲的美觀。

Material: Made from PE.

Usage: fix one end with safety belt first, then circle the wires clockwise to make them tighten.

Application: a protection wear for electric wires, and make them insulation and look nice.



型號 ITEM NO.	規格 SIZE	包裝 PACKING	
GS-10B	ø10mm	2.5m	10m
GS-15B	ø15mm	2.5m	10m
GS-20B	ø20mm	2.5m	10m
GS-25B	ø25mm	2.5m	10m
GS-30B	ø30mm	2.5m	10m
GS-40B	ø40mm	2.5m	10m



扎綫固定座 SADDLE TYPE TIE MOUNTS

材質: UL合格之NYLON 66(本色), 防火等級94V-2。

用途: 先將固定座以螺絲固定, 再以紮線帶繞綁電纜, 馬鞍形設計使電纜易於固定。

Material: UL approved Nylon 66, 94V-2

Application: Saddle design provide maximum stability to wire bundles. To apply, simply fix mount with a screw and secure wire bundles with HONT nylon cable ties.



型號 ITEM NO.	高 H	長 L	寬 W	帶孔 T	固定孔 B	包裝 Packing
GS-ST-1	7	15	10	5	3	每包100PCS
GS-ST-2	9	23	16	9	6	

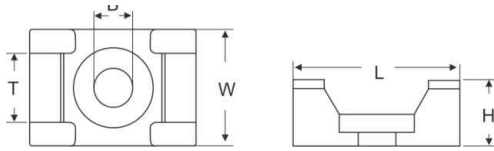

粘式扎綫固定座 CABLE TIE MOUNTS

材質: 採用UL認可之ABS,尼龍66制成, 防火等級94V-2。背附進口面海膠, 絕緣性能良好、耐久性、不易老化。

使用方法: 將定位片背面雙面膠撕開, 貼於機板固定, 再用紮帶捆紮電線。

用途: 省時、簡便、供面板不可以鉗孔時使用。

Material: UL approved Nylon 66, 94V-2, with imported adhesive sticker. Good insulation, long lasting and uneasy to age.

How to use: Remove the cover of the adhesive and stick the piece properly, then put in cable tie for using.

Application: Used where hole-drilling is not allowed. easy and time-saving.



型號 ITEM NO.	長×寬(mm) L × W	高 H (mm)	帶孔 T (mm)	外箱尺寸 (cm)	數量 PCS/CTN	毛重/淨重 KG
GS-20TM-A	20×20	6.1	5.0	52×35×36	20000	20/18
GS-25TM-A	25×25	7.5	6.2	52×35×36	10000	19/17
GS-30TM-A	30×30	8.7	6.4	54×33×32	6000	18/16
GS-40TM-A	40×40	6.4	10.8	54×33×32	3000	17/15
GS-25TM-B	25×25	7.5	6.2	52×35×36	10000	19/17
GS-30TM-B	30×30	8.7	6.4	54×33×32	6000	18/16

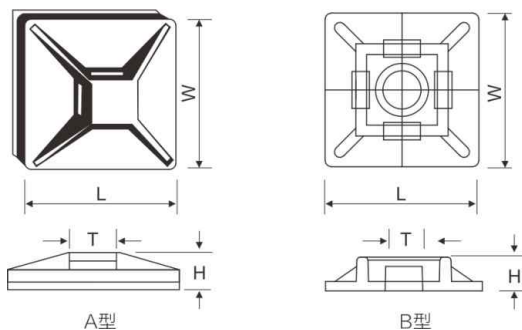



可調式扎綫固定座 ADJUST CABLE TIE MOUNTS

材質: UL 認可之尼龍66, 防火等級94V-2。

用途: 背膠式, 可快速拆卸, 固定電線, 維修方便, 不占空間。

Material: Nylon 66 94V-2 agreed by UL.

型號 ITEM NO.	A(束綫範圍)	B	C	D	E	F	包裝
GS-AM-0810	7.9~10.3	25.4	22.2	19.1	1.6	10.2	100
GS-AM-1013	10.0~12.5	31.8	27.8	19.1	1.6	10.2	100
GS-AM-1316	12.6~15.4	37.0	31.8	18.4	3.0	12.1	100
GS-AM-1720	16.5~20.1	42.0	37.0	25.0	3.0	12.7	100
GS-AM-2225	22.2~25.4	41.8	43.5	21.5	3.0	11.3	100

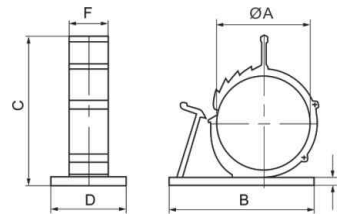

彈簧螺式接綫頭 WIRE CONNECTORS

材質: 採用PVC制成, 內有螺紋, 耐熱、絕緣。

使用方法: 將電線外皮剝去部分, 將所要接的電線, 同時插入扭緊即可。

用途: 電器制品之優良接綫器。

Material: PVC, threaded, Heat-resistant and insulating.

How to use: Put the joint of two wires into the cap and screw it in until it is tight. wall to secure the cable.

Application: Wire joining.

型號 ITEM NO.	高H (mm)	寬B (mm)	螺紋內徑C (mm)	適用電綫範圍 Wire Range	包裝 Std.PKg.
GS-P1	15.0	9.0	7.0	0.5-1.0mm ² (AWG22-18)	100PCS及 1000PCS
GS-P2	18.0	10.0	8.0	1.0-1.5mm ² (AWG18-16)	
GS-P3	23.0	11.0	10.0	1.5-2.5mm ² (AWG16-14)	100PCS及 500PCS
GS-P4	24.0	14.0	11.0	2.5-4mm ² (AWG14-12)	
GS-P6	28.0	16.0	13.0	4-6mm ² (AWG12-10)	100PCS及 500PCS
GS-P8	32.0	18.0	14.0	10-16mm ² (AWG 6)	

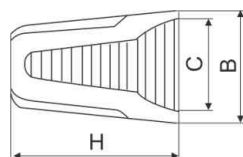

尼龍電纜接頭PG型 NYLON WATERPROOF CABLE GLAND PG TYPE

螺牙規格: PG牙

產品材質: A.C.F部分採用UL認可尼龍PA66(防火等級UL94V-2)制成, B.D部分採用丁睛橡膠(NBR)或三元乙丙耐候橡膠(EPDM)制成。

防護等級: IP68(在夾緊範圍內, 旋緊部位使用O型墊圈)

工作溫度: 靜態-40°C至100°C, 瞬間可耐熱至120°C, 動態-20°C至80°C, 瞬間可耐熱至100°C

產品特性: 夾緊電纜範圍大, 抗拉力強, 可以防水, 防塵, 抗鹽、耐弱酸、酒精、油脂及一般溶劑

顏色種類: 淺灰(RAL7035)、黑色(RAL9005), 特殊顏色可定做。

Thread: PG

Materials: Part A.C.F is made of UL approved nylon PA66(fire rating UL94V-2), part B.D butadiene rubber(NBR) or EPDM

Protection Degree: IP68(within fastening range, O type was her will be used in tightening part)

Working Temperature: -40°C to 100°C in static state, instantaneous heat resistance up to 120°C; -20°C to 80°C in dynamic state, instantaneous heat resistance up to 100°C

Product Features: Wide range for fastening cables, strong tensile strength, waterproof, dustproof, resistant to a cid and alkali, alcohol, grease and general solvents

Color: Light grey(RAL7035), black(RAL9005), other color can be customized according to request

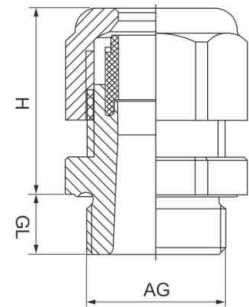
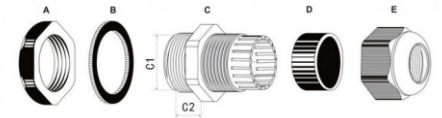

PG型 PG TYPE

產品型號 ITEM NO.	電纜範圍 Cable Range(mm) XØ	螺紋外徑 Thread O.D. AG(mm)	螺紋長度 Thread Length GL(mm)	接合長度 Joint Length H(mm)	扳手直徑 Spanner Size(mm) W
PG7-NL	3-6.5	12.5	8	21	18/17
PG7-NL	2-5	12.5	8	21	18/17
PG9-NL	4-8	15.2	8	22	22/19
PG9-NL	2-6	15.2	8	22	22/19
PG11-NL	5-10	18.6	9	25	24/22
PG11-NL	3-7	18.6	9	25	24/22
PG13.5-NL	6-12	20.4	10	27	27/24
PG13.5-NL	5-9	20.4	10	27	27/24
PG16-NL	10-14	22.5	10	28	30/27
PG16-NL	8-12	22.5	10	28	30/27
PG19-NL	12-16	24	10	30	30/27
PG19-NL	10-14	24	10	30	30/27
PG21-NL	13-18	28.3	10	31	36/33
PG21-NL	9-16	28.3	10	31	36/33
PG25-NL	16-21	30	11	36	37/36
PG25-NL	13-18	30	11	36	37/36
PG29-NL	18-25	37	12	37	46/42
PG29-NL	13-20	37	12	37	46/42
PG36-NL	22-32	47	14	48	58/52
PG36-NL	20-26	47	14	48	58/52
PG42-NL	32-40	54	14	49	64/60
PG42-NL	25-31	54	14	49	64/60
PG48-NL	37-44	59.3	14.5	49	70/64
PG48-NL	29-35	59.3	14.5	49	70/64
PG63-NL	42-50	71	28	50	82/77
PG63-NL	32-40	71	28	50	82/77

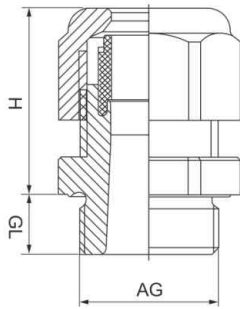
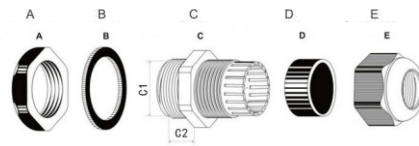

尼龍電纜接頭M型 NYLON WATERPROOF CABLE GLAND M TYPE

螺牙規格: 公牙制(Metric)

產品材質: A.C.F部分採用UL認可尼龍PA66(防火等級UL94V-2)制成, B.D部分採用丁腈橡膠(NBR)或三元乙丙耐侯橡膠(EPDM)制成。

防護等級: IP68(在夾緊範圍內, 旋緊部位使用O型墊圈)

工作溫度: 靜態-40°C至100°C, 瞬間可耐熱至120°C, 動態-20°C至80°C, 瞬間可耐熱至100°C

產品特性: 夾緊電纜範圍大, 抗拉力強, 可以防水, 防塵, 抗鹽、耐弱酸、酒精、油脂及一般溶劑
顏色種類: 淺灰(RAL7035)、黑色(RAL9005), 特殊顏色可定做。

Thread: Metric Type

Materials: Part A.C.F is made of UL approved nylon PA66(fire rating UL94V-2), part B.D butadiene rubber(NBR) or EPDM

Protection Degree: IP68(within fastening range, O type was her will be used in tightening part)

Working Temperature: -40°C to 100°C in static state, instantaneous heat resistance up to 120°C; -20°C to 80°C in dynamic state, instantaneous heat resistance up to 100°C

Product Features: Wide range for fastening cables, strong tensile strength, waterproof, dustproof, resistant to a cid and alkali, alcohol, grease and general solvents

Color: Light grey(RAL7035), black(RAL9005), other color can be customized according to request

M型 METRIC TYPE

產品型號 ITEM NO.	電纜範圍 Cable Range(mm) Ø	螺紋外徑 Thread O.D. AG(mm)	螺紋長度 Thread Length GL(mm)	接合長度 Joint Length H(mm)	扳手直徑 Spanner Size(mm) Ø
M12X1.5-NL	3-6.5	12	8	22	18/17
M12X1.5-NL	2-5	12	8	22	18/17
M12X1.5-NL	4-8	12	8	22	18/19
M12X1.5-NL	2-6	12	8	22	18/19
M16X1.5-NL	4-8	16	8	24	22/19
M16X1.5-NL	2-6	16	8	24	22/19
M16X1.5-NL	5-10	16	9	24	22/22
M16X1.5-NL	3-7	16	9	24	22/22
M18X1.5-NL	5-10	18	9	26	24/22
M18X1.5-NL	3-7	18	9	26	24/22
M20X1.5-NL	6-12	20	10	28	27/24
M20X1.5-NL	5-9	20	10	28	27/24
M20X1.5-NL	10-14	20	10	28	27/27
M20X1.5-NL	8-12	20	10	28	27/27
M22X1.5-NL	10-14	22	10	30	30/27
M22X1.5-NL	8-12	22	10	30	30/27
M24X1.5-NL	12-16	24	10	30	30/27
M24X1.5-NL	10-14	24	10	30	30/27
M25X1.5-NL	13-18	25	10	34	33/33
M25X1.5-NL	9-16	25	10	34	33/33
M27X1.5-NL	13-18	27	10	34	36/33
M27X1.5-NL	9-16	27	10	34	36/33
M30X1.5-NL	16-20	30	11	36	37/36
M30X1.5-NL	13-18	30	11	36	37/36
M32X1.5-NL	16-20	32	11	38	40/35
M32X1.5-NL	13-18	32	11	38	40/35
M32X1.5-NL	18-25	32	13	38	40/42
M32X1.5-NL	13-20	32	13	38	40/42
M36X1.5-NL	18-25	36	12	38	46/42
M36X1.5-NL	13-20	36	12	38	46/42
M40X1.5-NL	22-32	40	15	42	50/52
M40X1.5-NL	20-26	40	15	42	50/52
M50X1.5-NL	32-40	50	15	46	62/60
M50X1.5-NL	25-31	50	15	46	62/60
M63X1.5-NL	37-44	63	15	50	75/68
M63X1.5-NL	29-35	63	15	50	75/68

尼龍防折彎電纜接頭PG/M型

NYLON SPRIAL CABLE GLAND PG/METRIC TYPE

螺牙規格: PG牙/公牙制(Metric)

產品材質: A.C.F部分采用UL認可尼龍PA66(防火等級UL94V-2)制成, B.D部分采用丁睛橡膠(NBR)或三元乙丙耐候橡膠(EPDM)制成。

防護等級: IP68(在夾緊範圍內, 旋緊部位使用O型墊圈)

工作溫度: 靜態-40°C至100°C, 瞬間可耐熱至120°C, 動態-20°C至80°C, 瞬間可耐熱至100°C

產品特性: 夾緊電纜範圍大, 抗拉力強, 可以防水, 防塵, 抗鹽、耐弱酸、酒精、油脂及一般溶劑
顏色種類: 淺灰(RAL7035)、黑色(RAL9005), 特殊顏色可定做。

Thread: PG/Metric

Materials: Part A.C.F is made of UL approved nylon PA66(fire rating UL94V-2), part B.D butadiene rubber(NBR) or EPDM

Protection Degree: IP68(within fastening range, O type was her will be used in tightening part)

Working Temperature: -40°C to 100°C in static state, instantaneous heat resistance up to 120°C; -20°C to 80°C in dynamic state, instantaneous heat resistance up to 100°C

Product Features: Wide range for fastening cables, strong tensile strength, waterproof, dustproof, resistant to a cid and alkali, alcohol, grease and general solvents

Color: Light grey(RAL7035), black(RAL9005), other color can be customized according to request

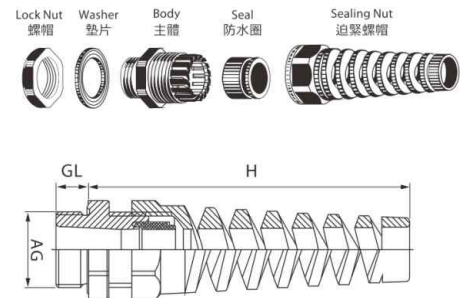

PG型 PG TYPE

產品型號 ITEM NO.	電纜範圍 Cable Range(mm) \varnothing	螺紋外徑 Thread O.D. AG(mm)	螺紋長度 Thread Length GL(mm)	接合長度 Joint Length H(mm)	扳手直徑 Spanner Size(mm) \varnothing
PG 7	3-6.5	12.5	8	54	18/17
PG 7	2-5	12.5	8	54	18/17
PG 9	4-8	15.2	8	63	22/19
PG 9	2-6	15.2	8	63	22/19
PG 11	5-10	18.6	9	78	24/22
PG 11	3-7	18.6	9	78	24/22
PG 13,5	6-12	20.4	10	90	27/24
PG 13,5	5-9	20.4	10	90	27/24
PG 16	10-14	22.5	10	100	30/27
PG 16	8-12	22.5	10	100	30/27
PG 21	13-18	28.3	10	114	36/33
PG 21	9-16	28.3	10	114	36/33

M型 METRIC TYPE

產品型號 ITEM NO.	電纜範圍 Cable Range(mm) \varnothing	螺紋外徑 Thread O.D. AG(mm)	螺紋長度 Thread Length GL(mm)	接合長度 Joint Length H(mm)	扳手直徑 Spanner Size(mm) \varnothing
M12x1.5	3-6.5	12	8	54	18/17
M12x1.5	2-5	12	8	54	18/17
M12x1.5	4-8	12	8	54	18/19
M12x1.5	2-6	12	8	54	18/19
M16x1.5	4-8	16	9	63	22/19
M16x1.5	2-6	16	9	63	22/19
M16x1.5	5-10	16	9	63	22/22
M16x1.5	3-7	16	9	63	22/22
M18x1.5	5-10	18	9	78	24/22
M18x1.5	3-7	18	9	78	24/22
M20x1.5	6-12	20	9	90	27/24
M20x1.5	5-9	20	10	90	27/24
M20x1.5	10-14	20	10	90	27/27
M20x1.5	8-12	20	10	90	27/27
M22x1.5	10-14	22	10	100	30/27
M22x1.5	8-12	22	10	100	30/27
M25x1.5	13-18	25	10	114	33/33
M25x1.5	9-16	25	10	114	33/33
M27x1.5	13-18	27	10	125	36/33
M27x1.5	9-16	27	10	125	36/33

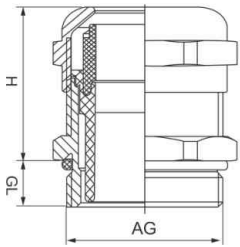

金屬電纜固定頭 METAL CABLE GLAND

螺牙規格: PG牙/公牙制(Metric)

產品材質: A.C.F部分採用黃銅鍍鎳制成, E部分採用UL認可尼龍PA66(防火等級UL94V-2)制成, B.D部分採用丁腈橡膠(NBR)或三元乙丙耐候橡膠(EPDM)制成。

防護等級: IP68(在夾緊範圍內, 旋緊部位使用O型墊圈)

工作溫度: 靜態-40°C至100°C, 瞬間可耐熱至120°C,

產品特性: 夾緊電纜範圍大, 抗拉力強, 可以防水, 防塵, 抗鹽、耐弱酸、酒精、油脂及一般溶劑

Thread: PG/Metric

Materials: Part A.C.F is made of UL certified nickel plated brass, part E is made of UL approved nylon PA66 (fire rating UL94V-2), part B.D butadiene rubber(NBR) or EPDM

Protection Degree: IP68(within fastening range, O type was her will be used in tightening part)

Working Temperature: -40°C to 100°C in static state, instantaneous heat resistance up to 120°C;

Product Features: Wide range for fastening cables, strong tensile strength, waterproof, dustproof, resistant to acid and alkali, alcohol, grease and general solvents

PG型 PG TYPE

產品型號 ITEM NO.	電纜範圍 Cable Range(mm) ⌀	螺紋外徑 Thread O.D. AG(mm)	螺紋長度 Thread Length GL(mm)	接合長度 Joint Length H(mm)	扳手直徑 Spanner Size(mm) ⌀
PG 7	3-6.5	12.5	6	19	14
PG 9	4-8	15.2	7	20	17
PG 11	5-10	18.6	7.5	21	20/21
PG 13,5	6-12	20.4	7.5	22	22
PG 16	10-14	22.5	7.5	23	24
PG 19	10-15	24	8	25	24/27
PG 21	13-18	28.3	8	27	30
PG 25	15-20	30	9	29	33
PG 29	18-25	37	9	31	40
PG 36	25-32	47	10	37	50
PG 42	32-38	54	11	38	57
PG 48	37-44	59.3	11	38	64

M型 METRIC TYPE

產品型號 ITEM NO.	電纜範圍 Cable Range(mm) ⌀	螺紋外徑 Thread O.D. AG(mm)	螺紋長度 Thread Length GL(mm)	接合長度 Joint Length H(mm)	扳手直徑 Spanner Size(mm) ⌀
M8x1	5.5-2	8	5	16	12
M10x1	6.5-3	10	7	19	14
M12x1.5	6.5-3	12	7	19	14
M14x1.5	8-4	14	7	19	17
M16x1.5	8-4	16	8	20	18
M18x1.5	10-5	18	8	21	20
M20x1.5	12-6	20	8	22	22
M22x1.5	14-10	22	8	23	24
M24x1.5	14-10	24	9	25	24
M25x1.5	14-10	25	9	25	24
M27x1.5	18-13	27	9	27	30
M28x1.5	18-13	28	9	27	30
M30x1.5	18-13	30	9	29	30
M32x1.5	22-15	32	10	29	35
M36x1.5	25-18	36	10	31	40
M40x1.5	25-18	40	11	31	40
M42x1.5	30-22	42	11	35	45
M48x1.5	33-25	48	11	37	50
M50x1.5	38-32	50	12	37	50
M54x1.5	38-32	54	12	38	57
M60x1.5	44-37	60	13	38	64
M63x1.5	44-37	63	13	38	64

金屬防折彎電纜接頭PG型

METAL SPIRAL CABLE GLAND PG TYPE

螺牙規格: PG牙/公牙制(Metric)

產品材質: A.C.F部分採用UL認可尼龍PA66(防火等級UL94V-2)制成, B.D部分採用丁腈橡膠(NBR)或三元乙丙耐候橡膠(EPDM)制成。

防護等級: IP68(在夾緊範圍內, 旋緊部位使用O型墊圈)

工作溫度: 靜態-40°C至100°C, 瞬間可耐熱至120°C, 動態-20°C至80°C, 瞬間可耐熱至100°C

產品特性: 夾緊電纜範圍大, 抗拉力強, 可以防水, 防塵, 抗鹽、耐弱酸、酒精、油脂及一般溶劑

顏色種類: 淺灰(RAL7035)、黑色(RAL9005), 特殊顏色可定做。

Thread: PG/Metric

Materials: Part A.C.F is made of UL approved nylon PA66(fire rating UL94V-2), part B.D butadiene rubber(NBR) or EPDM

Protection Degree: IP68(within fastening range, O type was her will be used in tightening part)

Working Temperature: -40°C to 100°C in static state, instantaneous heat resistance up to 120°C; -20°C to 80°C in dynamic state, instantaneous heat resistance up to 100°C

Product Features: Wide range for fastening cables, strong tensile strength, waterproof, dustproof, resistant to a cid and alkali, alcohol, grease and general solvents

Color: Light grey(RAL7035), black(RAL9005), other color can be customized according to request

PG型 PG TYPE

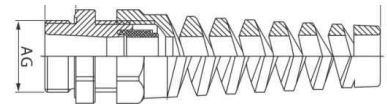

產品型號 ITEM NO.	電纜範圍 Cable Range(mm) ※ \varnothing k	螺紋外徑 Thread O.D. AG(mm)	螺紋長度 Thread Length GL(mm)	接合長度 Joint Length H(mm)	扳手直徑 Spanner Size(mm) \varnothing H
PG7	3-6.5	12.5	7	65	14
PG9	4-8	15.2	8	68	17
PG11	5-10	18.6	8	68	20
PG13.5	6-12	20.4	8	76	22
PG16	10-14	22.5	8	76	24
PG19	12-16	24.8	9	80	24
PG21	13-18	28.3	9	85	30
PG25	15-22	32	9	100	35
PG29	18-25	37	9	105	40

金屬防折彎電纜接頭 M型 METAL SPIRAL CABLE GLAND M TYPE

螺牙規格: PG牙/公牙制(Metric)

產品材質: A.C.F部分採用UL認可尼龍PA66(防火等級UL94V-2)制成, B.D部分採用丁腈橡膠(NBR)或三元乙丙耐侯橡膠(EPDM)制成。

防護等級: IP68(在夾緊範圍內, 旋緊部位使用O型墊圈)

工作溫度: 靜態-40°C至100°C, 瞬間可耐熱至120°C, 動態-20°C至80°C, 瞬間可耐熱至100°C

產品特性: 夾緊電纜範圍大, 抗拉力強, 可以防水, 防塵, 抗鹽、耐弱酸、酒精、油脂及一般溶劑

顏色種類: 淺灰(RAL7035)、黑色(RAL9005), 特殊顏色可定做。

Thread: PG/Metric

Materials: Part A.C.F is made of UL approved nylon PA66(fire rating UL94V-2), part B.D butadiene rubber(NBR) or EPDM

Protection Degree: IP68(within fastening range, O type was her will be used in tightening part)

Working Temperature: -40°C to 100°C in static state, instantaneous heat resistance up to 120°C; -20°C to 80°C in dynamic state, instantaneous heat resistance up to 100°C

Product Features: Wide range for fastening cables, strong tensile strength, waterproof, dustproof, resistant to a cid and alkali, alcohol, grease and general solvents

Color: Light grey(RAL7035), black(RAL9005), other color can be customized according to request

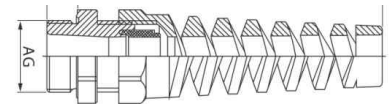

M型 METRIC TYPE

產品型號 ITEM NO.	電纜範圍 Cable Range(mm) ∅k	螺紋外徑 Thread O.D. AG(mm)	螺紋長度 Thread Length GL(mm)	接合長度 Joint Length H(mm)	扳手直徑 Spanner Size(mm) H
M12X1.5	3-6.5	12	7	65	14
M12X1.5	4-8	12	8	68	17
M14X1.5	4-8	14	8	68	17
M16X1.5	4-8	16	8	68	17
M16X1.5	5-10	16	8	75	20
M18X1.5	5-10	18	8	75	20
M20X1.5	6-12	20	8	76	22
M20X1.5	10-14	20	8	80	24
M22X1.5	10-14	22	8	80	24
M24X1.5	10-14	24	9	80	24
M24X1.5	12-16	24	9	86	27
M25X1.5	10-14	25	9	80	30
M25X1.5	12-16	25	9	86	30
M25X1.5	13-18	25	9	100	30
M27X1.5	13-18	27	9	100	30
M27X1.5	15-22	27	9	100	30
M28X1.5	13-18	28	9	100	30
M30X1.5	13-18	30	9	100	30
M30X1.5	15-22	30	10	105	35
M32X1.5	15-22	32	10	105	35
M32X1.5	18-25	32	10	112	40
M33X1.5	15-22	33	10	105	35
M36X1.5	18-25	36	10	112	40
M37X1.5	18-25	37	10	112	40
M40X1.5	25-33	40	11	120	45
M42X1.5	22-30	42	11	120	45
M47X1.5	25-33	47	11	130	50
M48X1.5	25-33	48	11	130	50
M50X1.5	32-38	50	12	135	55
M54X1.5	32-38	54	12	135	55
M56X1.5	32-38	56	13	135	55
M60X1.5	37-44	60	13	142	64
M63X1.5	37-44	63	14	142	64
M64X1.5	37-44	64	14	142	64
M70X1.5	42-52	70	15	150	72
M72X1.5	42-52	72	15	150	72
M75X1.5	42-52	75	15	150	72
M80X1.5	52-62	80	16	158	86

快速电线接头 Wire Connector Quick-Connect Terminal Blocks

外壳材料: 阻燃尼龙;
导电材料: 铜镀镍;
额定电压/额定电流: 440V/32A.

Shell materials: Nylon flame retardant material.
Conductive material: Nickel-plated copper.
Rated voltage/rated current: 440V/32A.

型号 ITEM NO.	外壳 SHELL	接线范围 Wire range(mm ²)	规格 SPECIFICATION
PCT-221	Opaque	0.08-4.0	1-1
PCT-221	Opaque	0.08-4.0	2-2
PCT-223	Opaque	0.08-4.0	3-3
PCT-224	Opaque	0.08-4.0	4-4
PCT-225	Opaque	0.08-4.0	5-5
PCT-221-T	Transparent	0.08-4.0	1-1
PCT-222-T	Transparent	0.08-4.0	2-2
PCT-223-T	Transparent	0.08-4.0	3-3
PCT-224-T	Transparent	0.08-4.0	4-4
PCT-225-T	Transparent	0.08-4.0	5-5



快速电线接头 Wire Connector Quick-Connect Terminal Blocks

外壳材料: 阻燃尼龙;
导电材料: 铜镀镍;
额定电压/额定电流: 440V/32A.

Shell materials: Nylon flame retardant material.
Conductive material: Nickel-plated copper.
Rated voltage/rated current: 440V/32A.

型号 ITEM NO.	外壳 SHELL	接线范围 Wire range(mm ²)	规格 SPECIFICATION
FD-12	Opaque	0.08-4.0	1-2
FD-12A	Opaque	0.08-4.0	1-2
FD-12B	Opaque	0.08-4.0	1-2
FD-13	Opaque	0.08-4.0	1-3
FD-13A	Opaque	0.08-4.0	1-3
FD-13B	Opaque	0.08-4.0	1-3
FD-12-T	Transparent	0.08-4.0	1-2
FD-12A-T	Transparent	0.08-4.0	1-2
FD-12B-T	Transparent	0.08-4.0	1-2
FD-13-T	Transparent	0.08-4.0	1-3
FD-13A-T	Transparent	0.08-4.0	1-3
FD-13B-T	Transparent	0.08-4.0	1-3

